

58.00

TOWNSHIP OF MARPLE
227 S. Sproul Road
Broomall, PA 19008
610-356-4040 Fax 610-356-8751

Panel: 25000200800
APPROVED/REJECTED
[Signature] 8/8/24
Signature of Inspector/ Date

Permit Fee:	\$ 50.00
Ucc Fee:	8.00
CO Fee:	
TOTAL:	\$ 58.00

Approved U&O Class _____

Approved Construction Type _____

PERMIT FORM

DATE: 8/2/24 PERMIT #: 24-Per-3427-P1 ZONING DISTRICT: _____ MAX.IMP.COV. _____ Zoning Compliance _____

Is property on Historical Resource List? Y N Historical Commission _____

Building Permit/General _____ Plumbing Electrical _____ Mechanical _____ Sprinkler _____

Low Voltage Wiring _____ Accessory Structure _____ Pod/Temp.Stor.Unit _____ Other _____ Accessibility _____

Property Owners Information: Name: Walter Mayer

Address: 57 S. Main Road, Broomall, PA 19008

Property Location: 57 S Main Road Phone Number: (610) 742-8551

Give definite particulars as to work proposed and materials used. For additions please attach plot plan and building details on 8x11 sheet of paper. For fencing permits you are required to have your property surveyed. Survey date: _____

REPLACE WATER HEATER: ① 50 gal gas

Project Cost: \$1913-

EMERGENCY
Date of Commencing: INSTALLATION

Notwithstanding the issuance of this permit, all provisions of the Building and Zoning Codes must be complied with, whether specified herein or not. Certified copies of all contracts must be presented in conjunction with permit application. Further, the department of Code Enforcement has the right to conduct a re-evaluation of cost at completion of the project or prior to issuance of Certificate of Occupancy, when deemed necessary. Construction sites must be kept clean at all times. Overflowing dumpsters and unkempt sites will result in permits being revoked. Signs are only allowed 2 days prior to construction and 48 hours after completion of work.

Contractor Information: Building/General _____ ID# _____

Address: 2 GOURMET LANE, UNIT H, EDISON, NJ 08837 Phone Number: (732) 417-0099 X 105

ELECTRICAL: _____ ID# _____ Phone #: _____

PLUMBER: 1 800 HEATERS INC ID# PA057842 Phone # (732) 417-0099 X 105

MECHANICAL: _____ ID# _____ Phone #: _____

SPRINKLER: _____ ID# _____ Phone #: _____

PROPERTY OWNER'S SIGNATURE: _____ DATE: _____

CONTRACTOR'S SIGNATURE: *[Signature]* PA# 057842 DATE: 8/2/2024
(MARK McCLAIN)



NATURAL GAS



PROPANE GAS



The new degree of comfort

Fuel Type	Nominal Gallon Capacity	Rated Gallon Capacity	Household Size	First Hour Delivery	Estimated Yearly Energy Cost**	Uniform Energy Factor (UEF)	Tank Height	Tank Diam.	Vent Diam.	Model #	SKU
PERFORMANCE PLATINUM™											
Performance Platinum - ENERGY STAR® V200 Induced Draft (requires 110 Volt electrical connection)											
Natural Gas	29	28	3 to 5	93	\$260	0.71	58-1/4	17-3/4	3 or 4	XG29T12XR000	1000053211
Performance Platinum - ENERGY STAR® Powered Damper Gas Products with EcoNet™ Valve Module Included (requires 110 Volt electrical connection)											
Natural Gas	50	48	3 to 5	78	\$271	0.68	58-1/2	21-3/4	3 or 4	XG50T12DM400W	1001712601
Natural Gas	40	37	2 to 4	85	\$264	0.70	58	19-3/4	3 or 4	XG40T12DM400W	1001712523
Natural Gas	40	39	2 to 4	69	\$186	0.65	50-1/2	21-3/4	3 or 4	XG40S12DM400W	1001712581
Performance Platinum - ENERGY STAR® Powered Damper Gas Products (requires 110 Volt electrical connection)											
Natural Gas	50	48	3 to 5	78	\$271	0.68	58-1/2	21-3/4	3 or 4	XG50T12DM400	1000034939
Natural Gas	50	48	3 to 5	78	\$271	0.68	50-1/2	23-3/4	3 or 4	XG50S12DM400	1000034937
Natural Gas	40	37	2 to 4	85	\$264	0.70	58	19-3/4	3 or 4	XG40T12DM400	1000034938
Natural Gas	40	39	2 to 4	69	\$186	0.65	50-1/2	21-3/4	3 or 4	XG40S12DM400	1000034935
Liquid Propane	50	48	3 to 5	78	\$657	0.68	58-1/2	21-3/4	3 or 4	XP50T12DM360	Special Order
Liquid Propane	50	48	3 to 5	79	\$657	0.68	50-1/2	23-3/4	3 or 4	XP50S12DM360	Special Order
Liquid Propane	38	37	2 to 4	85	\$638	0.70	58	19-3/4	3 or 4	XP40T12DM360	1000034936
Liquid Propane	40	39	2 to 4	69	\$450	0.65	50-1/2	21-3/4	3 or 4	XP40S12DM360	1000034934
Performance Platinum - Self Powered Diagnostic Control - High Efficiency											
Natural Gas	75	73	5+	100	\$302	0.61	60-1/4	26-1/4	4	XG75T12S1760	Special Order
Natural Gas	55	55	3 to 5	97	\$298	0.62	59-7/8	23-3/4	4	XG55T12E0500	Special Order
Natural Gas	50	48	3 to 5	77	\$288	0.64	59-1/4	21-1/2	3 or 4	XG50T12H4000	1000034941
Natural Gas	40	38	2 to 4	84	\$284	0.65	60-1/4	19-1/2	3 or 4	XG40T12H4000	1000034940
Natural Gas	40	39	2 to 4	69	\$208	0.58	50-1/4	21-1/2	3	XG40S12H3600	1000035078
Liquid Propane	50	48	3 to 5	77	\$598	0.64	59-1/4	21-1/2	3 or 4	XP50T12H3600	1001310504
Liquid Propane	40	38	2 to 4	84	\$687	0.65	60-1/4	19-1/2	3 or 4	XP40T12H3600	1001310500
Liquid Propane	40	39	2 to 4	69	\$504	0.58	50-1/4	21-1/2	3	XP40S12H3600	Special Order
PERFORMANCE PLUS™											
Performance Plus - Self Powered Diagnostic Control - High Efficiency											
Natural Gas	50	48	3 to 5	77	\$288	0.64	59-1/4	21-1/2	3 or 4	XG50T09H4000	1000035246
Natural Gas	40	38	2 to 4	81	\$284	0.65	60-1/4	19-1/2	3 or 4	XG40T09H4000	1000035200
Natural Gas	40	39	2 to 4	68	\$208	0.58	50-1/4	21-1/2	3	XP40S09H3600	1000035197
Liquid Propane	50	48	3 to 5	77	\$698	0.64	59-1/4	21-1/2	3 or 4	XP50T09H3600	1001316511
Liquid Propane	40	38	2 to 4	81	\$687	0.65	60-1/4	19-1/2	3 or 4	XP40T09H3600	1001310508
Liquid Propane	40	39	2 to 4	68	\$504	0.58	50-1/4	21-1/2	3	XP40S09H3600	1000035364
PERFORMANCE®											
Performance - Self Powered Diagnostic Control - High Efficiency											
Natural Gas	50	48	3 to 5	75	\$288	0.64	59-1/4	21-1/2	3 or 4	XG50T06H4000	1000034916
Natural Gas	40	39	2 to 4	67	\$206	0.58	50-1/4	21-1/2	3	XG40S06H3600	Special Order
Liquid Propane	40	39	2 to 4	67	\$504	0.58	50-1/4	21-1/2	3	XP40S06H3600	Special Order
Performance - Self Powered Diagnostic Control											
Natural Gas	50	48	3 to 5	85	\$293	0.63	58-1/4	20-1/2	3 or 4	XG50T06EC360	1001300139
Natural Gas	50	48	3 to 5	86	\$288	0.64	51	23-3/4	3 or 4	XG50S06EC400	1001300196
Natural Gas	40	38	2 to 4	68	\$206	0.58	58-1/2	19	3 or 4	XG40T06EC360	1001300147
Natural Gas	40	38	2 to 4	64	\$208	0.58	49-1/4	21	3 or 4	XG40S06EC340	1001300161
Natural Gas	30	29	2 or Less	55	\$201	0.60	46-1/4	19-3/4	3 or 4	XG30S06EC300	1001300189
Natural Gas	29	28	2 or Less	62	\$201	0.60	56-1/2	16-1/2	3 or 4	XG29T06EC320	1001300168
Liquid Propane	50	48	3 to 5	85	\$709	0.63	58-1/4	20-1/2	3 or 4	XP50T06EC360	1001299110
Liquid Propane	40	38	2 to 4	69	\$479	0.61	58-1/2	18-1/2	3 or 4	XP40T06EC320	1001299039
Liquid Propane	29	28	2 or Less	62	\$487	0.60	56-1/2	16-1/2	3 or 4	XP29T06EC300	1001299033
Performance - High Demand											
Natural Gas	98	93	5+	142	\$318	0.58	64	27-1/4	4	XG98T06S1760	1001300421
Natural Gas	75	73	5+	100	\$302	0.61	60-1/4	26-1/4	4	XG75T06S1760	1001300190
Natural Gas	55	55	5+	97	\$298	0.62	58	23-3/4	4	XG55T06EC0500	1001300185
Liquid Propane	98	93	5+	142	\$770	0.58	64	27-1/4	4	XP98T06S1760	Special Order
Liquid Propane	75	73	5+	100	\$732	0.61	60-1/4	26-1/4	4	XP75T06S1760	1001299116
Liquid Propane	55	55	5+	97	\$720	0.62	58	23-3/4	3 or 4	XP55T06ECAS0	Special Order
Performance - Direct Vent											
Natural Gas	50	48	3 to 5	51	\$216	0.56	59-1/2	21-3/4	6	XG50T06DV360	1001292665
Performance - Manufactured Housing Atmospheric Vent Convertible Gas Control Valve											
Nat. LP	40	38	2 to 4	67	\$205	0.59	58-1/2	18-1/2	3 or 4	XG40T06MH34U	1001300123
Nat. LP	29	28	2 or Less	52	\$201	0.60	56-1/2	16-1/2	3 or 4	XG29T06MH32U	1001300119
Performance - Manufactured Housing Direct Vent With Convertible Gas Control Valve											
Nat. LP	40	38	2 to 4	58	\$205	0.59	57-1/2	19-3/4	3	XG40T06MD30U	1001300130
Nat. LP	30	29	2 or Less	46	\$146	0.57	57	17-3/4	3	XG30T06MD30U	1001300128
Performance - Power Vent (requires 110 Volt electrical connection)											
Natural Gas	75	73	5+	119	\$313	0.59	60-1/4	26-1/4	3 or 4	XG75T06PV760	1001298661
Natural Gas	50	48	3 to 5	78	\$271	0.68	58	21-3/4	2 or 3	XG50T06PV420	1000035144
Natural Gas	40	38	2 to 4	86	\$267	0.69	59	19-3/4	2 or 3	XG40T06PV400	1000035126
Liquid Propane	50	48	3 to 5	78	\$657	0.68	58	21-3/4	2 or 3	XP50T06PV420	1000035147
Liquid Propane	40	38	2 to 4	86	\$647	0.69	59	19-3/4	2 or 3	XP40T06PV360	1000035141



WIFI compatible
ENERGY STAR® compliant

- Uniform Energy Factor and Energy Factor based on Department of Energy (D.O.E.) requirements.
- Check dimensions on carton at time of purchase. Dimensions and specifications are subject to change without notice in accordance with our policy of continuous product improvement.
- Some models may not be available in all markets.
- All residential gas models have 3/4" NPT water connections, excluding 75 and 98 gallon tanks which have 1" water connections.
- See written warranty for complete details.

* Available for water heaters to the water heater's first hour delivery rating as required by the Department of Energy's test procedures.

** Estimated energy cost based on a national average fuel cost of \$1.00 per gallon for natural gas and \$1.44 per gallon for LP. Before purchasing this appliance, read important information about the estimated annual energy consumption, yearly operating cost of energy efficiency rating that is available from your retailer.

SAME DAY INSTALLATION IF YOU CALL BEFORE 12PM • Call 1-800-HOMEDEPOT (1-800-466-3337) before 12PM or ask an Associate for details



CERTIFICATE OF LIABILITY INSURANCE

DATE (MM/DD/YYYY)

03/25/2024

THIS CERTIFICATE IS ISSUED AS A MATTER OF INFORMATION ONLY AND CONFERS NO RIGHTS UPON THE CERTIFICATE HOLDER. THIS CERTIFICATE DOES NOT AFFIRMATIVELY OR NEGATIVELY AMEND, EXTEND OR ALTER THE COVERAGE AFFORDED BY THE POLICIES BELOW. THIS CERTIFICATE OF INSURANCE DOES NOT CONSTITUTE A CONTRACT BETWEEN THE ISSUING INSURER(S), AUTHORIZED REPRESENTATIVE OR PRODUCER, AND THE CERTIFICATE HOLDER.

IMPORTANT: If the certificate holder is an **ADDITIONAL INSURED**, the policy(ies) must have **ADDITIONAL INSURED** provisions or be endorsed. If **SUBROGATION IS WAIVED**, subject to the terms and conditions of the policy, certain policies may require an endorsement. A statement on this certificate does not confer rights to the certificate holder in lieu of such endorsement(s).

PRODUCER Armfield, Harrison & Thomas, LLC dba JGS Insurance Agency 101 Crawfords Comer Rd, #1300 Holmdel NJ 07733-1978	CONTACT NAME: Andre Jones PHONE (A/C, No, Ext): (877) 547-4671 E-MAIL ADDRESS: ajones@jgsinsurance.com	FAX (A/C, No): (732) 834-0233	
	INSURER(S) AFFORDING COVERAGE		NAIC #
INSURED 1 800 Heaters Inc. 2 Goumet Lane, Unit-H Edison NJ 08837	INSURER A: Harleysville Worcester Insurance Company		26182
	INSURER B: Harleysville Insurance Company of New Jersey		42900
	INSURER C:		
	INSURER D:		
	INSURER E:		
	INSURER F:		

COVERAGES

CERTIFICATE NUMBER: 24-25 All Lines

REVISION NUMBER:

THIS IS TO CERTIFY THAT THE POLICIES OF INSURANCE LISTED BELOW HAVE BEEN ISSUED TO THE INSURED NAMED ABOVE FOR THE POLICY PERIOD INDICATED. NOTWITHSTANDING ANY REQUIREMENT, TERM OR CONDITION OF ANY CONTRACT OR OTHER DOCUMENT WITH RESPECT TO WHICH THIS CERTIFICATE MAY BE ISSUED OR MAY PERTAIN, THE INSURANCE AFFORDED BY THE POLICIES DESCRIBED HEREIN IS SUBJECT TO ALL THE TERMS, EXCLUSIONS AND CONDITIONS OF SUCH POLICIES. LIMITS SHOWN MAY HAVE BEEN REDUCED BY PAID CLAIMS.

INSR LTR	TYPE OF INSURANCE	ADDL INSD	SUBR WVD	POLICY NUMBER	POLICY EFF (MM/DD/YYYY)	POLICY EXP (MM/DD/YYYY)	LIMITS
A	<input checked="" type="checkbox"/> COMMERCIAL GENERAL LIABILITY <input type="checkbox"/> CLAIMS-MADE <input checked="" type="checkbox"/> OCCUR GENL AGGREGATE LIMIT APPLIES PER: <input type="checkbox"/> POLICY <input type="checkbox"/> PRO-JECT <input checked="" type="checkbox"/> LOC OTHER:			MPA00000051784L	03/30/2024	03/30/2025	EACH OCCURRENCE \$ 1,000,000 DAMAGE TO RENTED PREMISES (Ea occurrence) \$ 1,000,000 MED EXP (Any one person) \$ 15,000 PERSONAL & ADV INJURY \$ 1,000,000 GENERAL AGGREGATE \$ 2,000,000 PRODUCTS - COMP/OP AGG \$ 2,000,000
B	<input checked="" type="checkbox"/> AUTOMOBILE LIABILITY <input checked="" type="checkbox"/> ANY AUTO <input type="checkbox"/> OWNED AUTOS ONLY <input type="checkbox"/> SCHEDULED AUTOS NON-OWNED AUTOS ONLY <input type="checkbox"/> HIRED AUTOS ONLY			BA00000051783L	03/30/2024	03/30/2025	COMBINED SINGLE LIMIT (Ea accident) \$ 1,000,000 BODILY INJURY (Per person) \$ BODILY INJURY (Per accident) \$ PROPERTY DAMAGE (Per accident) \$
A	<input checked="" type="checkbox"/> UMBRELLA LIAB <input checked="" type="checkbox"/> OCCUR <input type="checkbox"/> EXCESS LIAB <input type="checkbox"/> CLAIMS-MADE DED <input checked="" type="checkbox"/> RETENTION \$ 0			CMB00000051782L	03/30/2024	03/30/2025	EACH OCCURRENCE \$ 5,000,000 AGGREGATE \$ 5,000,000
A	WORKERS COMPENSATION AND EMPLOYERS' LIABILITY ANY PROPRIETOR/PARTNER/EXECUTIVE OFFICER/MEMBER EXCLUDED? (Mandatory in NH) If yes, describe under DESCRIPTION OF OPERATIONS below	Y/N	N/A	WC0000001328BP	03/30/2024	03/30/2025	<input checked="" type="checkbox"/> PER STATUTE <input type="checkbox"/> OTH-ER E.L. EACH ACCIDENT \$ 1,000,000 E.L. DISEASE - EA EMPLOYEE \$ 1,000,000 E.L. DISEASE - POLICY LIMIT \$ 1,000,000

DESCRIPTION OF OPERATIONS / LOCATIONS / VEHICLES (ACORD 101, Additional Remarks Schedule, may be attached if more space is required)

CERTIFICATE HOLDER**CANCELLATION**

Marple Township 227 South Sproul Road Broomall PA 19008	SHOULD ANY OF THE ABOVE DESCRIBED POLICIES BE CANCELLED BEFORE THE EXPIRATION DATE THEREOF, NOTICE WILL BE DELIVERED IN ACCORDANCE WITH THE POLICY PROVISIONS. AUTHORIZED REPRESENTATIVE 
---	--

© 1988-2015 ACORD CORPORATION. All rights reserved.

Commonwealth of Pennsylvania

Office of Attorney General

THIS IS TO CERTIFY THAT

1 800 HEATERS INC.
2 GOURMET LANE
UNIT G & H
EDISON NJ 08837

HAS REGISTERED IN PENNSYLVANIA AS A HOME IMPROVEMENT CONTRACTOR

11/3/2025

VALID UNTIL

PA057842

REGISTRATION NUMBER



SIGNATURE OF REGISTRATION CERTIFICATE HOLDER



MICHELLE A. HENRY, ATTORNEY GENERAL



Township Of Marple

227 S. Sproul Road
Broomall, PA 19008
Phone: 601-356-4040
Fax: 610-356-8751
www.marpletwp.com

Fee Receipt

Date : 08/08/2024

Receipt Number : 13927

To:

Permit Number : 24-PER-3427-P1

1 800 heaters inc.

2 Gourmet Ln. Unit H

Edison, NJ 08837

Settlement Date : 08/08/2024

For:

25000296800

57 S MALIN RD

Residential - New Construction, Alteration, Additions, Inground Pools

Plumbing

Transaction Details:

Transaction Number	Payment Method	Transaction Type	Amount	Balance
3927	Check 103310	Payment	\$ 58.00	0.00

Fee Summary:

Cash Payments : \$0.00

Check Payments : \$58.00

Thank You for your Payment!

Township of Marple

Springfield & Sproul Roads
Broomall, PA 19008

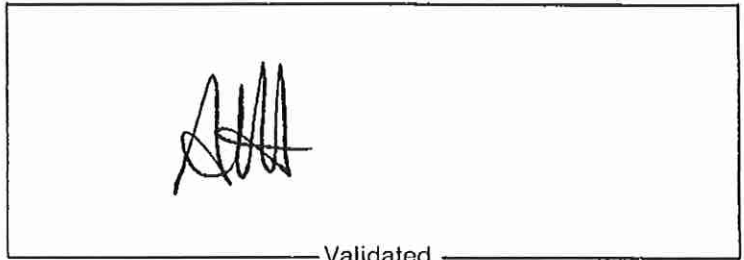

Present Bldg. Single Family

New Bldg. or Add. Repl. Windows

Validated _____

Dist. _____ Permit Fee 15.00 Permit No. 98-1823 Date _____ Time _____

ABOVE PORTION OF THE APPLICATION TO BE COMPLETED BY TOWNSHIP.

APPLICATION FOR PERMIT FOR ADDITIONS, ALTERATIONS, REPAIRS, TOOL SHEDS, GARAGES, DEMOLITIONS, FENCES, ETC.

I, We hereby apply for a permit to construct the following work (Give exact location):

Owner MR & MRS JAMES MULGREW Phone 356-1691

Street and Number 57 MAIN RD

Give definite particulars as to work proposed and materials used:

REMOVE/INSTALL 5 DOUBLE HUNG.

Project Costs 1000.00 Time of Commencing BT 6/08

Certified copies of all building and alteration contracts must be presented in conjunction with permit application when requested by this department.

The department has the right to conduct a reevaluation of costs at completion of the project or prior to issuance of Certificate of Occupancy, when deemed necessary.

General Contractor _____ Phone 325 0788

Thermal Quality
Window & Door Co.
2988 Dogwood Lane
Broomall, PA 19008

Address _____

Electrical Contractor _____ Phone _____

Address _____

Plumbing Contractor _____ Phone _____

Address _____

Roofing Contractor _____ Phone _____

Address _____

Other Subcontractors _____

Notwithstanding the issuance of this permit, all provisions of the Building and Zoning Codes will be complied with, whether specified herein or not.

Applicant must draw sketch of house and any outbuildings on the lot, existing or to be erected, and indicated dimensions from each building to each property line and between buildings.

REAR PROPERTY LINE

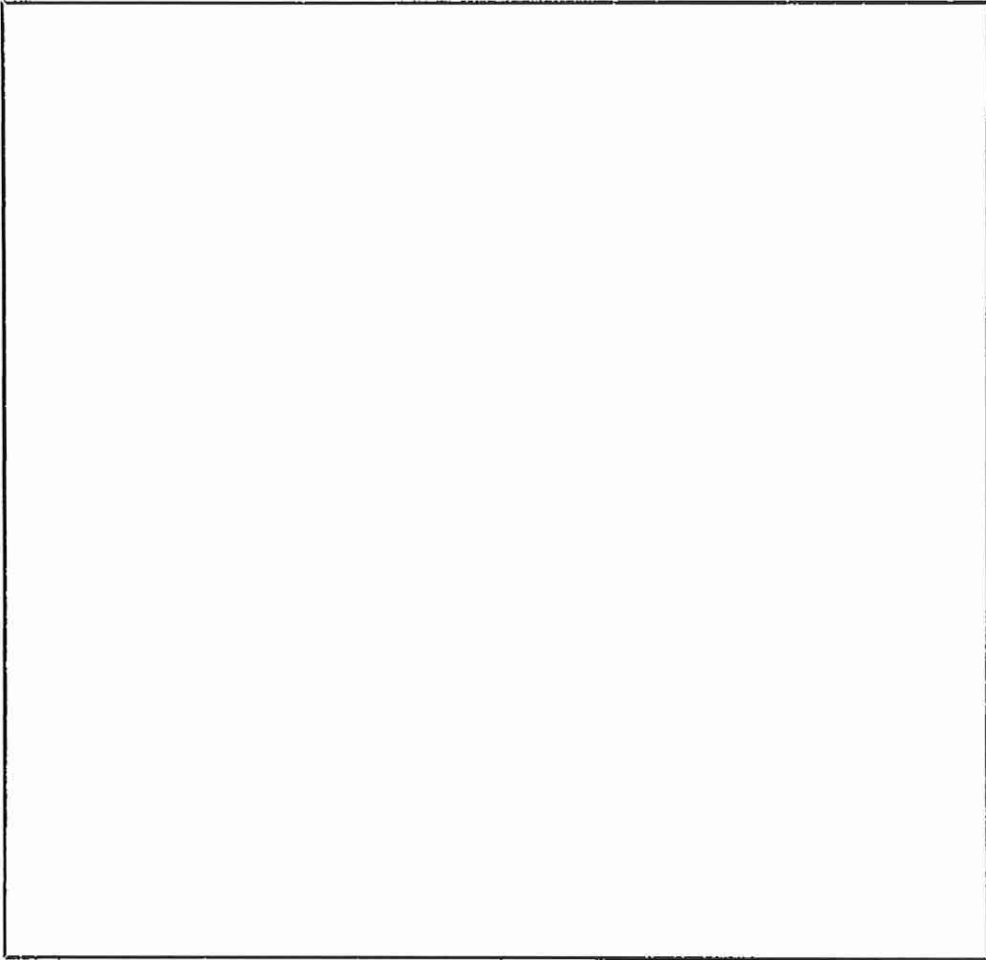

FRONT PROPERTY LINE

FOR NOTARY PUBLIC

Sworn and subscribed before me this day of, 19....

.....

My Commission expires

Applicant's Signature

A handwritten signature in black ink, appearing to read "Ken Lane", written over a horizontal dotted line.

TOWNSHIP OF MARPLE
DELAWARE COUNTY, PENNSYLVANIA
PERMITS AND FEES

No 98 - 1823

JUNE 18, 19 98

Fee, \$ 15.00

Thermal Quality, 2988 Dogwood, Broomall
Name Street City

has made application for permits or fees indicated below, in accordance with the terms and conditions set forth in the applicable Township Ordinance.

Location of Work 57 MAIN RD
Owner MULGREW
Address

1. Building Estimated Cost \$ 1,000 Proposed Use Zoning District
() New Construction () Addition () Alteration (X) Repair - Replacement WINDOWS
() Accessory Structure () Demolition () Concrete () Other

2. Plumbing Residential Nonresidential Plumber Reg. No.
() New Work () Alteration/Repair/Replacement () Sewer Connect () Onsite System
() Water service () Hot Water Heater () Main Drain Repair/Replacement () Other

3. Mechanical Residential Nonresidential
A. Heating () New () Replacement
() Hot Air () Hot Water () Oil () Electric () Gas () Other
B. Air Conditioning () New () Replacement

4. Electrical Residential Nonresidential
() New Work () Repair/Replacement () Alterations () Other

5. Fire Protection Residential Nonresidential
() Fire Suppression Systems () Fire Detection Systems () Other

6. Street Opening Location Escrow Deposit \$
Purpose Opening Dimensions
Date of Work Length of time open

7. Other
() Special Bulk Refuse Collection Description
() Grading Permit
() Zoning Hearing
()

In consideration of the sum of 15.00 Dollars, permission is hereby granted to the above applicant to proceed with the work as described in the application for said permit. The applicant agrees to assume all liability for, and save harmless the Township of Marple from any and all damages which may result from this purpose. The permit is subject to immediate revocation by the Township for any violation of the applicable Township Ordinances and the permittee is subject to the penalties provided by law. The permit expires COMOS.

() RECEIPT OF FEES ONLY PURPOSE

Received payment,
[Signature]
TOWNSHIP MANAGER

06/18/98 10:42AM GEN'L \$15.00

TOWNSHIP OF MARPLE

Springfield and Sproul Roads
Broomall, Pennsylvania 19008
(610) 356-4040 Fax (610) 356-8751

DATE <u>7/14/98</u>	PERMIT NO.
PROJECT	
LOCATION <u>104 Martins Run</u>	
CONTRACTOR	OWNER <u>Fronhold</u>
WEATHER	TEMP. / TIME
PRESENT AT SITE	

TO: _____

THE FOLLOWING WAS NOTED:

A Bonding inspection was completed
System is grounded - no tag was seen.

COPIES TO _____

FIELD REPORT

SIGNED Robert P. Eli

Township of Marple

Springfield & Sproul Roads
Broomall, PA 19008

Present Bldg. _____

New Bldg. or Add. _____

Dist. _____ Permit Fee 15.00 Permit No. 97-1065 Date 4/10/97 Time _____ Validated _____

ABOVE PORTION OF THE APPLICATION TO BE COMPLETED BY TOWNSHIP.

**APPLICATION FOR PERMIT FOR ADDITIONS, ALTERATIONS,
REPAIRS, TOOL SHEDS, GARAGES, DEMOLITIONS, FENCES, ETC.**

I, We hereby apply for a permit to construct the following work (Give exact location):

Owner MR & MRS J MULGREW Phone 356-1691

Street and Number 57 S MALIN RD

Give definite particulars as to work proposed and materials used:

FINISH/INSTALL 4 DOUBLE HUNG

Project Costs 995.00 Time of Commencing 4-10-97

Certified copies of all building and alteration contracts must be presented in conjunction with permit application when requested by this department.

The department has the right to conduct a reevaluation of costs at completion of the project or prior to issuance of Certificate of Occupancy, when deemed necessary.

General Contractor _____ Phone 325 0788

Address _____

Electrical Contractor _____ Phone _____

Address _____

Plumbing Contractor _____ Phone _____

Address _____

Roofing Contractor _____ Phone _____

Address _____

Other Subcontractors _____

Notwithstanding the issuance of this permit, all provisions of the Building and Zoning Codes will be complied with, whether specified herein or not.

Applicant must draw sketch of house and any outbuildings on the lot, existing or to be erected, and indicated dimensions from each building to each property line and between buildings:

REAR PROPERTY LINE

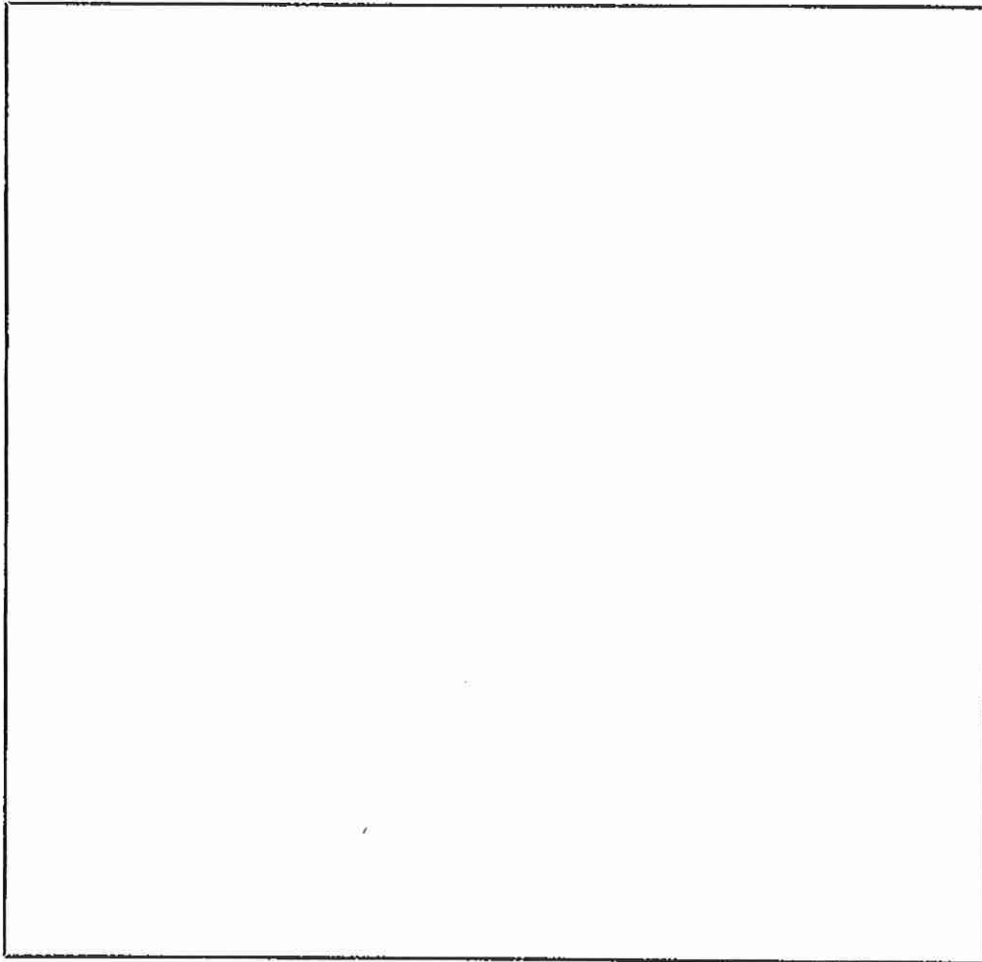

FRONT PROPERTY LINE

FOR NOTARY PUBLIC

Sworn and subscribed before me this 4th day of April, 1997

Mary R. Renshaw

My Commission expires Jan. 20, 1998

NOTARIAL SEAL
MARY R. RENSHAW, Notary Public
Marple Twp., Delaware Co.
My Commission Expires Jan. 20, 1998

Applicant's Signature [Handwritten Signature]

CODE	REV			
	DISB			

TOWNSHIP OF MARPLE
DELAWARE COUNTY, PENNSYLVANIA

No 97 - 1065

PERMITS AND FEES

April 10, 1997

Fee, \$ 15.00

Thermal Quality, 2988 Dogwood, Broomall, PA
Name Street City

has made application for permits or fees indicated below, in accordance with the terms and conditions set forth in the applicable Township Ordinances.

1. **Building** Estimated Cost \$ 995.00 Zone _____
 New Dwelling Garage Addition Alteration-Repair
 Other Bip Utilin

2. **Plumbing** Reg. No. _____
 New Work Alterations Sewer Cesspool & Septic Tank
 Oil Burner Gas Appliance Plumber's Registration
 Other _____

3. **Storage of Explosives** Purpose _____
 No. of pounds _____ Type _____

4. **Blasting** Purpose _____ Bond () Insurance ()
 Type of explosive _____ Maximum charge _____
 Special Requirements (including date and time) _____

Supervisor of blasting _____ Address _____
 Penna. Blaster's License No.: _____

For Items No. 1, No. 2, No. 3 and No. 4	Location of Work <u>57 S Malin Rd</u> Owner _____ Address _____
--	---

5. **Street Opening** Location _____
 Purpose _____ Dimensions _____
 Date of work _____ Length of time open _____

6. **Other** Location _____
 Subdivision Plan Filing Engineer and Date of Plan _____
 Board of Adjustment Hearing No. of Hours _____
 Engineering Inspection
 Code Book Building Plumbing Zoning Subdivision
 Change of Zoning Hearing

In consideration of the sum of \$15.00 Dollars, permission is hereby granted to the above applicant to proceed with the work as described in the application for this permit, which by reference is made a part hereof. The applicant agrees to assume all liability for, and save harmless the Township of Marple from any and all damages which may result from this purpose. This permit is subject to immediate revocation by the Township for any violation of the applicable Township Ordinances and the permittee is subject to the penalties provided by law. This permit expires 6 mos.

Received payment,
J. Flicker/MS
 TOWNSHIP MANAGER

Copy to: Police Chief Tax Assessor Building Inspector Roadmaster
 Plumbing Inspector Refuse Site Custodian Board of Adjustment Manager

Township of Marple

Springfield & Sproul Roads
Broomall, PA 19008

APPROVED BY MARPLE TWP.
BLDG. INSPECTOR
_____ INK _____ Date 10/11/96
Validated _____

Present Bldg. _____

New Bldg. or Add. _____

Dist. _____ Permit Fee 30.00 Permit No. 96-2836 Date 10-11-96 Time _____

ABOVE PORTION OF THE APPLICATION TO BE COMPLETED BY TOWNSHIP.

APPLICATION FOR PERMIT FOR ADDITIONS, ALTERATIONS, REPAIRS, TOOL SHEDS, GARAGES, DEMOLITIONS, FENCES, ETC.

I, We hereby apply for a permit to construct the following work (Give exact location):

Owner MR + MRS J MULLGREW Phone 356-1691

Street and Number 57 S MAIN RD

Give definite particulars as to work proposed and materials used:

FURNISH / INSTAL 1 Flat unit (3) Casements &
11 1 DOUBLE HUNG.

Project Costs 1490.00 Time of Commencing B) 11/3

Certified copies of all building and alteration contracts must by presented in conjunction with permit application when requested by this department.

The department has the right to conduct a reevaluation of costs at completion of the project or prior to issuance of Certificate of Occupancy, when deemed necessary.

General Contractor _____ Phone 325 0788

Address Thermal Quality Window & Door Co.
2988 Dogwood Lane
Broomall, PA 19008

Electrical Contractor _____ Phone _____

Address _____

Plumbing Contractor _____ Phone _____

Address _____

Roofing Contractor _____ Phone _____

Address _____

Other Subcontractors _____

Notwithstanding the issuance of this permit, all provisions of the Building and Zoning Codes will be complied with, whether specified herein or not.

Applicant must draw sketch of house and any outbuildings on the lot, existing or to be erected, and indicated dimensions from each building to each property line and between buildings.

REAR PROPERTY LINE

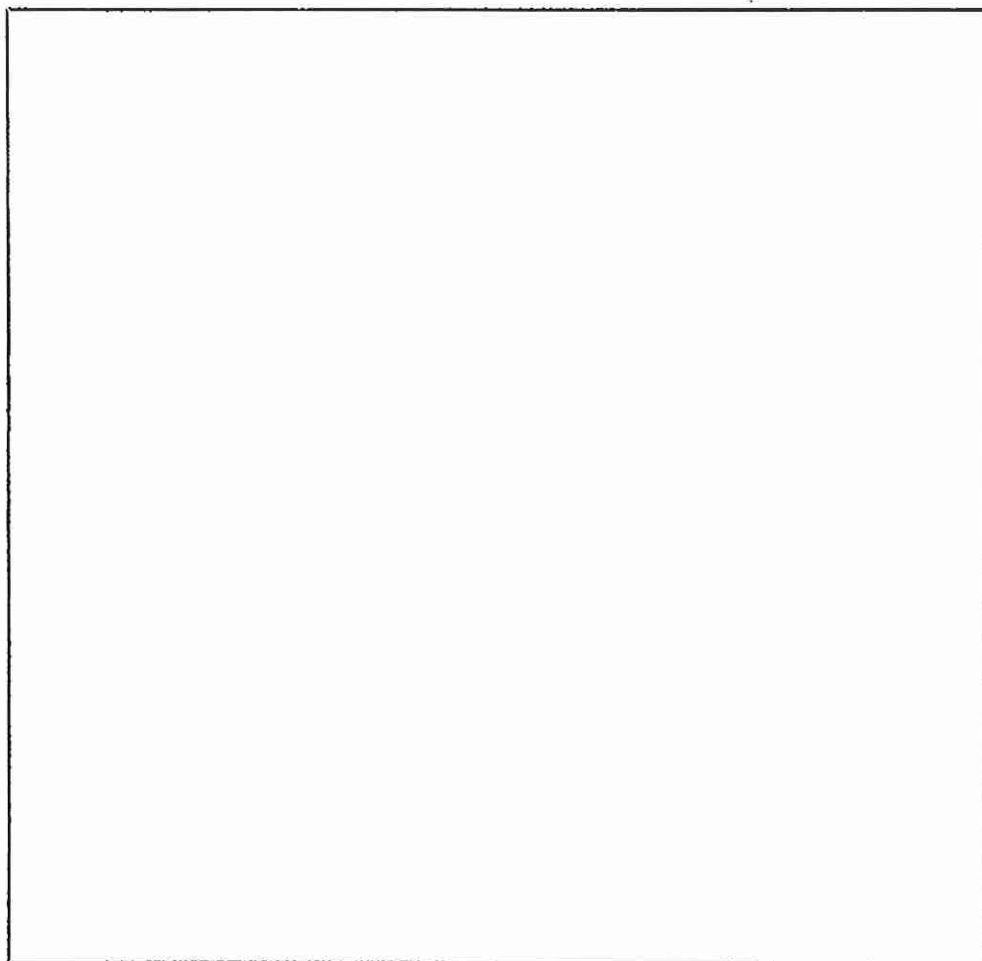

FRONT PROPERTY LINE

FOR NOTARY PUBLIC

Sworn and subscribed before me this day of, 19....

.....

My Commission expires

Applicant's Signature

A handwritten signature in black ink, written over a dotted line. The signature is cursive and appears to read "Ken J. Lawrence".

CODE	REV				
	DISB				

TOWNSHIP OF MARPLE
DELAWARE COUNTY, PENNSYLVANIA

No 96 - 2836

PERMITS AND FEES

Oct. 11, 1996

Fee, \$ 30.00

Thermal Quality, 2988 Dogwood Lane, Broomall, PA
Name Street City

has made application for permits or fees indicated below, in accordance with the terms and conditions set forth in the applicable Township Ordinances.

1. **Building** Estimated Cost \$ 1490.00 Zone _____
 New Dwelling Garage Addition Alteration-Repair
 Other Rep. Windows
2. **Plumbing** Reg. No. _____
 New Work Alterations Sewer Cesspool & Septic Tank
 Oil Burner Gas Appliance Plumber's Registration
 Other _____

3. **Storage of Explosives** Purpose _____
 No. of pounds _____ Type _____

4. **Blasting**
 Purpose _____ Bond () Insurance ()
 Type of explosive _____ Maximum charge _____
 Special Requirements (including date and time) _____

Supervisor of blasting _____ Address _____
 Penna. Blaster's License No.: _____

For Items	Location of Work <u>57 S. Main Rd.</u>
No. 1, No. 2, No. 3 and No. 4	Owner _____
	Address _____

5. **Street Opening** Location _____
 Purpose _____ Dimensions _____
 Date of work _____ Length of time open _____
6. **Other** Location _____
 Subdivision Plan Filing Engineer and Date of Plan _____
 Board of Adjustment Hearing No. of Hours _____
 Engineering Inspection
 Code Book Building Plumbing Zoning Subdivision
 Change of Zoning Hearing

In consideration of the sum of \$30.00 Dollars, permission is hereby granted to the above applicant to proceed with the work as described in the application for this permit, which by reference is made a part hereof. The applicant agrees to assume all liability for, and save harmless the Township of Marple from any and all damages which may result from this purpose. This permit is subject to immediate revocation by the Township for any violation of the applicable Township Ordinances and the permittee is subject to the penalties provided by law. This permit expires 6 mos.

Received payment
J. Flicker/MS
 TOWNSHIP MANAGER

- Copy to: Police Chief Tax Assessor Building Inspector Roadmaster
 Plumbing Inspector Refuse Site Custodian Board of Adjustment Manager

Township of Marple

Springfield & Sproul Roads
Broomall, PA 19008

APPROVED BY MARPLE TWP.
BLDG. INSPECTOR

TWK Date 4-16-96

Present Bldg. _____

New Bldg. or Add. _____

Validated _____

Dist. _____ Permit Fee \$ 20.00 Permit No. 96-1019 Date _____ Time _____

ABOVE PORTION OF THE APPLICATION TO BE COMPLETED BY TOWNSHIP.

APPLICATION FOR PERMIT FOR ADDITIONS, ALTERATIONS, REPAIRS, TOOL SHEDS, GARAGES, DEMOLITIONS, FENCES, ETC.

I, We hereby apply for a permit to construct the following work (Give exact location):

Owner Jim & Diane Mulsew Phone 356-1691

Street and Number 57 S. MALIN

Give definite particulars as to work proposed and materials used:

Construct 84 FT - 6 FT high Privacy fence and 71 ft - 5 ft high
Cyclone fence

Project Costs approx \$700.00 Time of Commencing within 2 wks

Certified copies of all building and alteration contracts must be presented in conjunction with permit application when requested by this department.

The department has the right to conduct a reevaluation of costs at completion of the project or prior to issuance of Certificate of Occupancy, when deemed necessary.

General Contractor _____ Phone _____

Address _____

Electrical Contractor _____ Phone _____

Address _____

Plumbing Contractor _____ Phone _____

Address _____

Roofing Contractor _____ Phone _____

Address _____

Other Subcontractors _____

Notwithstanding the issuance of this permit, all provisions of the Building and Zoning Codes will be complied with, whether specified herein or not.

Applicant must draw sketch of house and any outbuildings on the lot, existing or to be erected, and indicated dimensions from each building to each property line and between buildings.

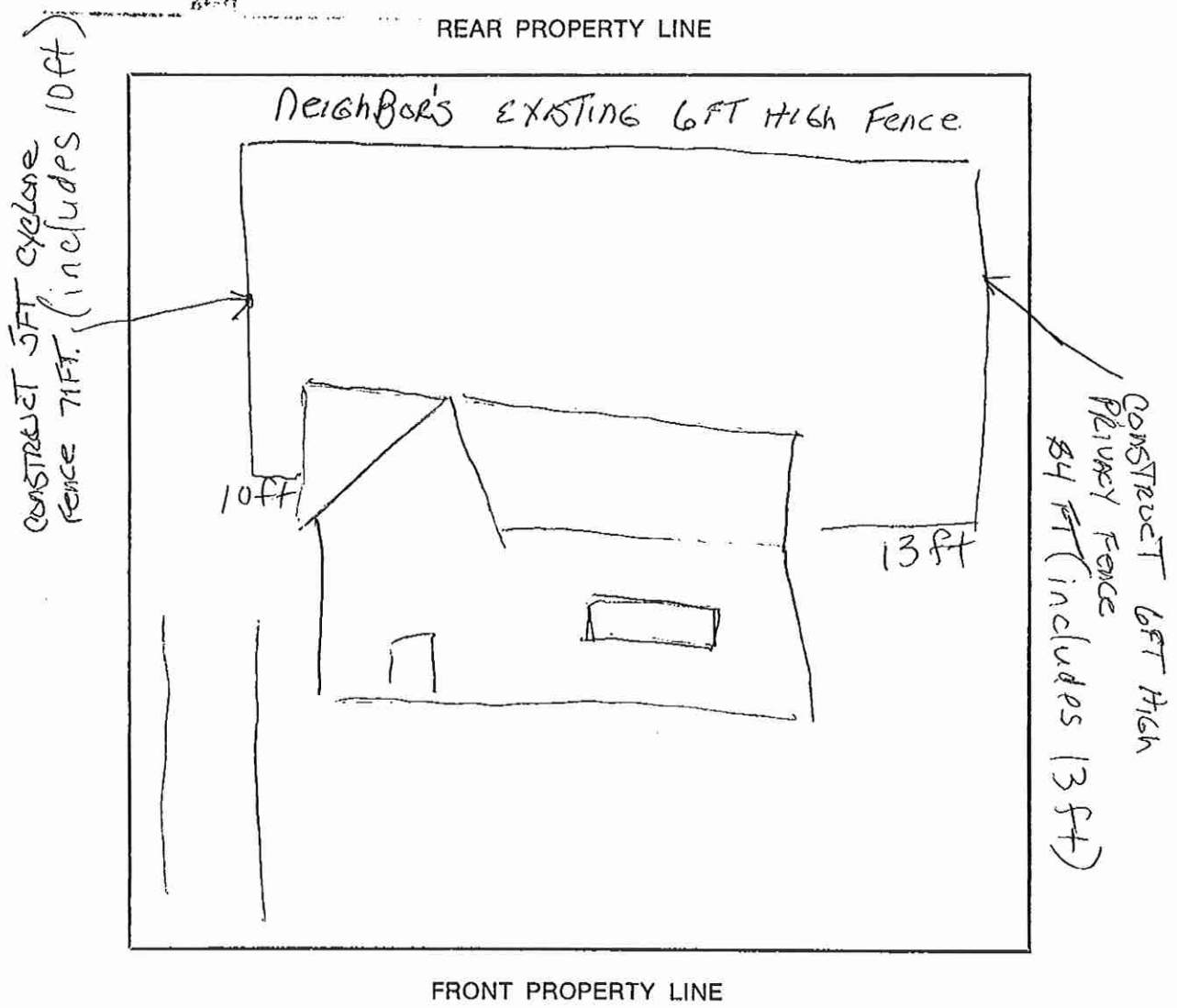

FRONT PROPERTY LINE

FOR NOTARY PUBLIC

Sworn and subscribed before me this day of, 19....

.....

My Commission expires

Applicant's Signature *James Malpas*

CODE	REV			
	DISB			

TOWNSHIP OF MARPLE
DELAWARE COUNTY, PENNSYLVANIA

No 96 - 1019

PERMITS AND FEES

Fee, \$ 20.00

4-16, 1996
Jean & Diane Mulgrew 57 D. Malin
Name Street City

Bloomington

has made application for permits or fees indicated below, in accordance with the terms and conditions set forth in the applicable Township Ordinances.

1. **Building** Estimated Cost \$ 700 - Zone _____
 New Dwelling Garage Addition Alteration-Repair
 Other fence
2. **Plumbing** Reg. No. _____
 New Work Alterations Sewer Cesspool & Septic Tank
 Oil Burner Gas Appliance Plumber's Registration
 Other _____

3. **Storage of Explosives** Purpose _____
 No. of pounds _____ Type _____

4. **Blasting**
 Purpose _____ Bond () Insurance ()
 Type of explosive _____ Maximum charge _____
 Special Requirements (including date and time) _____

Supervisor of blasting _____ Address _____
 Penna. Blaster's License No.: _____

For Items No. 1, No. 2, No. 3 and No. 4	Location of Work Owner Address
--	--------------------------------------

5. **Street Opening** Location _____
 Purpose _____ Dimensions _____
 Date of work _____ Length of time open _____

6. **Other** Location _____
 Subdivision Plan Filing Engineer and Date of Plan _____
 Board of Adjustment Hearing No. of Hours _____
 Engineering Inspection
 Code Book Building Plumbing Zoning Subdivision
 Change of Zoning Hearing

In consideration of the sum of \$200 Dollars, permission is hereby granted to the above applicant to proceed with the work as described in the application for this permit, which by reference is made a part hereof. The applicant agrees to assume all liability for, and save harmless the Township of Marple from any and all damages which may result from this purpose. This permit is subject to immediate revocation by the Township for any violation of the applicable Township Ordinances and the permittee is subject to the penalties provided by law. This permit expires 6 months.

Received payment,

TOWNSHIP MANAGER

- Copy to: Police Chief Tax Assessor Building Inspector Roadmaster
 Plumbing Inspector Refuse Site Custodian Board of Adjustment Manager

Township of Marple

Springfield & Sproul Roads
Broomall, PA 19008

APPROVED BY MARPLE TWP.
BLDG. INSPECTOR

Wm. J. ... Date 5-23-95
Validated _____

Present Bldg. _____

New Bldg. or Add. _____

Dist. _____ Permit Fee \$100.00 Permit No. _____

Date _____ Time _____

ABOVE PORTION OF THE APPLICATION TO BE COMPLETED BY TOWNSHIP.

APPLICATION FOR PERMIT FOR ADDITIONS, ALTERATIONS, REPAIRS, TOOL SHEDS, GARAGES, DEMOLITIONS, FENCES, ETC.

I, We hereby apply for a permit to construct the following work (Give exact location):

Owner Jim Mulbrew Phone _____

Street and Number 57 S. Malin rd.

Give definite particulars as to work proposed and materials used:

2x10 Joists, 2x10 supports, 6x6x posts, and 4x4
Railing posts, 2x6 Railing Cap, 2x2 Spindles
Supports and post Lagged together with 6" Lag bolts.

Project Costs 3800 Time of Commencing 5/24/95

Certified copies of all building and alteration contracts must be presented in conjunction with permit application when requested by this department.

The department has the right to conduct a reevaluation of costs at completion of the project or prior to issuance of Certificate of Occupancy, when deemed necessary.

General Contractor Robt. Copeland Home Imp. Phone 356-1705

Address 2405 N. Greenhill rd Broomall

Electrical Contractor _____ Phone _____

Address _____

Plumbing Contractor _____ Phone _____

Address _____

Roofing Contractor _____ Phone _____

Address _____

Other Subcontractors _____

Notwithstanding the issuance of this permit, all provisions of the Building and Zoning Codes will be complied with, whether specified herein or not.

Township of Marple

Springfield & Sproul Roads
Broomall, PA 19008

APPROVED BY MARPLE TWP.
BLDG. INSPECTOR
Wm Seidel Date 5-23-95
Validated _____

Present Bldg. _____

New Bldg. or Add. _____

Dist. _____ Permit Fee \$100.00 Permit No. _____

Date _____ Time _____

ABOVE PORTION OF THE APPLICATION TO BE COMPLETED BY TOWNSHIP.

**APPLICATION FOR PERMIT FOR ADDITIONS, ALTERATIONS,
REPAIRS, TOOL SHEDS, GARAGES, DEMOLITIONS, FENCES, ETC.**

I, We hereby apply for a permit to construct the following work (Give exact location):

Owner Jim Mulbrew Phone _____

Street and Number 57 S. Malin rd.

Give definite particulars as to work proposed and materials used:

2x10 Joists, 2x10 supports, 6x6x posts, and 4x4
Railing Posts, 2x6 Railing Cap, 2x2 Spindles
Supports and Post Lagged together with 6" Lag bolts.

Project Costs 3800 @ Time of Commencing 5/24/95

**Certified copies of all building and alteration contracts must be presented in conjunction with permit application when requested by this department.
The department has the right to conduct a reevaluation of costs at completion of the project or prior to issuance of Certificate of Occupancy, when deemed necessary.**

General Contractor Robt Copeland Home Imp Phone 356-1705

Address 2405 N. Greenhill rd Broomall

Electrical Contractor _____ Phone _____

Address _____

Plumbing Contractor _____ Phone _____

Address _____

Roofing Contractor _____ Phone _____

Address _____

Other Subcontractors _____

Notwithstanding the issuance of this permit, all provisions of the Building and Zoning Codes will be complied with, whether specified herein or not.

Applicant must draw sketch of house and any outbuildings on the lot, existing or to be erected, and indicated dimensions from each building to each property line and between buildings.

REAR PROPERTY LINE

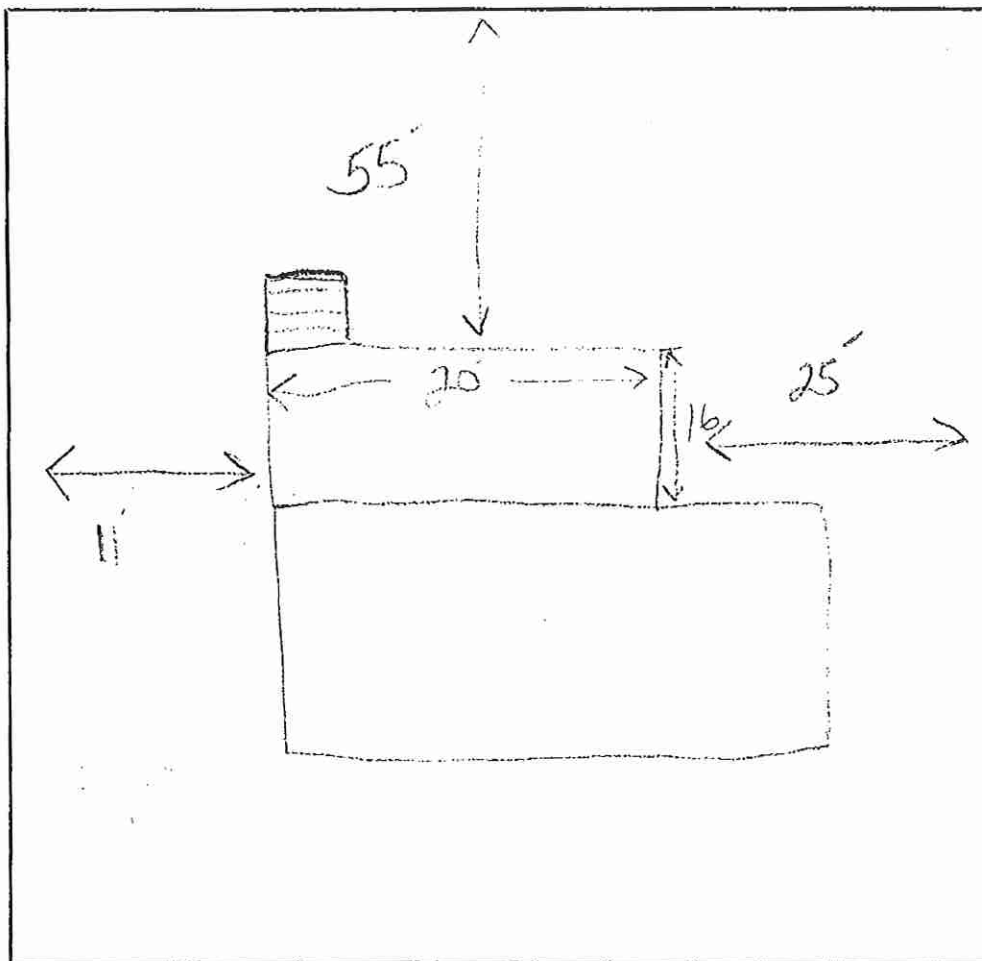

133.84

FRONT PROPERTY LINE

50

FOR NOTARY PUBLIC

Sworn and subscribed before me this day of, 19....

My Commission expires

Applicant's Signature

Robert M. Capel

side view

All Lumber used will be Pressure treated Lumber.

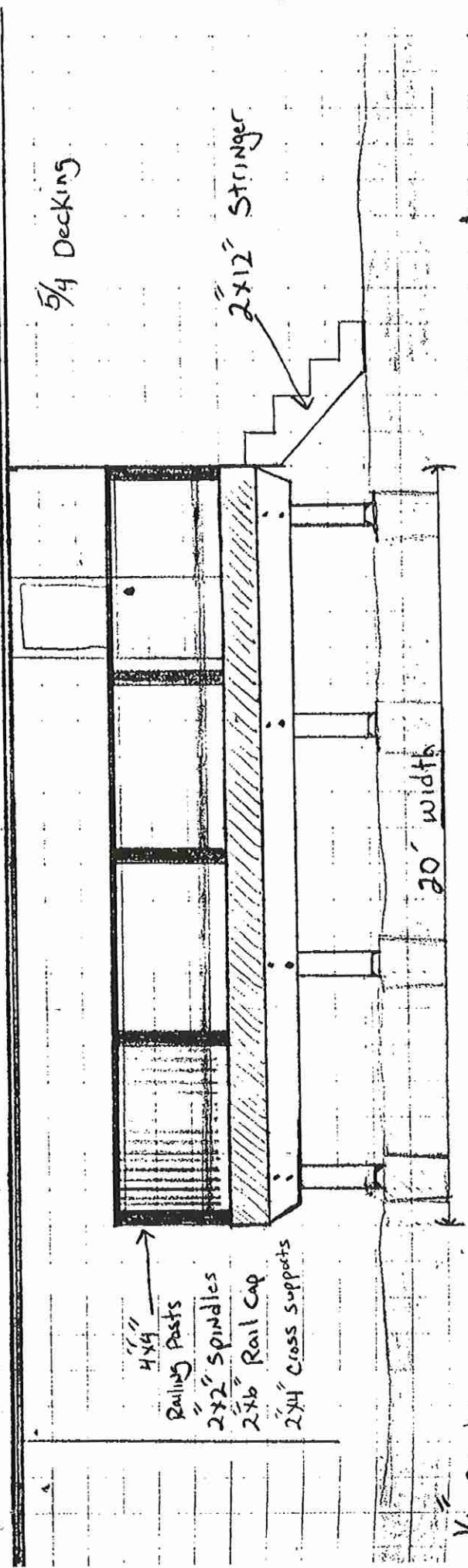
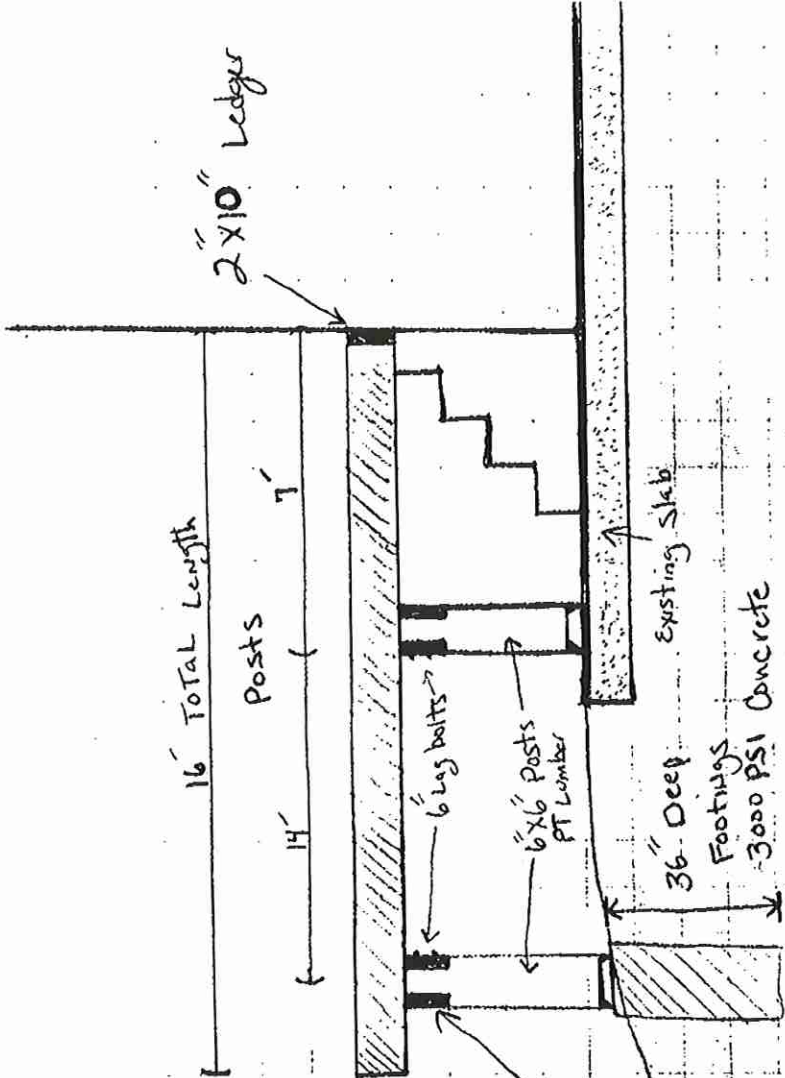

1/4 Scale

57 S. Malin Rd.
Broomall

MARPLE

TOWNSHIP OF MARPLE
SPRINGFIELD AND SPROUL ROADS
BROOMALL, PA 19008
(610) 356-4040
(610) 356-8751 FAX
LEE GERSHENFELD, DIRECTOR

REQUEST FOR INSPECTION

NAME: _____ DATE: _____

ADDRESS: 57 S. Marple PERMIT #: _____

DATE OF INSPECTION: 6-23-95 PHONE #: _____

COMMENTS:

* Please check & see if they are
working on a deal.
Never picked up permit

PROJECT: Not working

TYPE OF INSPECTION: _____ APPROVED: _____ REJECTED: _____

INSPECTOR: S. G. DATE: 6/23/95 TIME: _____

BUILDING PERMIT # _____

ELECTRICAL PERMIT # _____ STICKER # _____
(electrical)

PLUMBING PERMIT # _____

HEAT/AIR PERMIT # _____

SPRINKLER PERMIT # _____

MARPLE

TOWNSHIP OF MARPLE
SPRINGFIELD AND SPROUL ROADS
BROOMALL, PA 19008
(610) 356-4040
(610) 356-8751 FAX
LEE GERSHENFELD, DIRECTOR

REQUEST FOR INSPECTION

NAME: _____ DATE: _____

ADDRESS: 57 S. Malvern Rd PERMIT #: _____

DATE OF INSPECTION: 6-5-95 PHONE #: _____

COMMENTS: _____

deck - see working

PROJECT: Not working

TYPE OF INSPECTION: _____ APPROVED: _____ REJECTED: _____

INSPECTOR: RD DATE: _____ TIME: _____

BUILDING PERMIT # _____

ELECTRICAL PERMIT # _____

PLUMBING PERMIT # _____

HEAT/AIR PERMIT # _____

SPRINKLER PERMIT # _____

STICKER # _____

(electrical)

Township of Marple

Springfield & Sproul Roads
Broomall, PA 19008

APPROVED BY MARPLE TWP.
BLDG. INSPECTOR

JNK Date 10-6-92

Class
Present Bldg.
New Bldg. or Add. Validated
Dist. Permit Fee 15.00 Permit No. 92-3227 Time

ABOVE PORTION OF THE APPLICATION TO BE COMPLETED BY TOWNSHIP

APPLICATION FOR PERMIT FOR ADDITIONS, ALTERATIONS,
REPAIRS, TOOL SHEDS, GARAGES, DEMOLITIONS, FENCES, ETC.

TO THE BOARD OF COMMISSIONERS OF MARPLE TOWNSHIP:

I (We) hereby apply for a permit to construct the following work (Give exact location):

Street and number 57 S Marple Road
Broomall Pa 19008

Dimensions of Lot Number of streets on which bldg. will front

Distance of bldg. from Property Line Side Side

Front Line Rear Line

Give definite particulars as to work proposed and materials used:

Remove & Replace Concrete

6 Blocks, Apron

Estimated Cost 600 Time of Commencing

Electrical Permit Plumbing Permit

Notwithstanding the issuance of this permit, all provisions of the Building and Zoning Codes will be complied with, whether specified herein or not.

Owner Miller Real Estate Phone

Address 57 S Marple Road

Contractor Kostack Construction Inc Phone 256-9333

Address PO Box 248

Applicant // Phone

Address

Date Oct 0 1992

Applicant must draw sketch of house and any outbuildings on the lot, existing or to be erected, and indicated dimensions from each building to each property line and between buildings:

REAR PROPERTY LINE

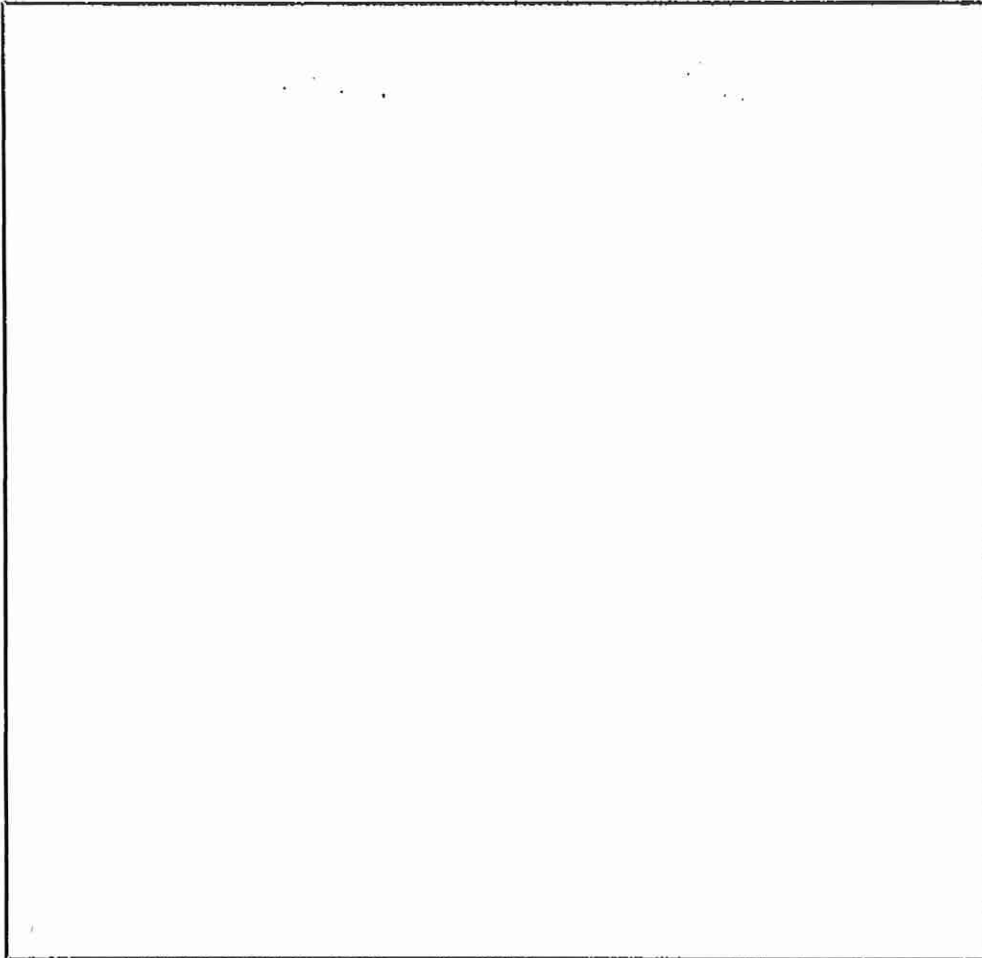

FRONT PROPERTY LINE

NOTARIAL SEAL
HOPE S. SMITH, Notary Public
Marple Twp., Delaware County, Pa.
My Commission Expires June 24, 1998

FOR NOTARY PUBLIC

Sworn and subscribed before me this 7 day of Oct, 1992

My Commission expires

Applicant's Signature [Handwritten Signature]

CODE	REV				
	DISB				

TOWNSHIP OF MARPLE
DELAWARE COUNTY, PENNSYLVANIA

92 - 3227

PERMITS AND FEES

Oct 6, 1992

Fee, \$ 15.00

Hostack Const Box 748 Broomall PA.
Name Street City

has made application for permits or fees indicated below, in accordance with the terms and conditions set forth in the applicable Township Ordinances.

1. **Building** Estimated Cost \$ 600.00 Zone _____
 New Dwelling Garage Addition Alteration-Repair
 Other 6 Blocks
2. **Plumbing** Reg. No. _____
 New Work Alterations Sewer Cesspool & Septic Tank
 Oil Burner Gas Appliance Plumber's Registration
 Other _____

3. **Storage of Explosives** Purpose _____
 No. of pounds _____ Type _____

4. **Blasting** Purpose _____ Bond () Insurance ()
 Type of explosive _____ Maximum charge _____
 Special Requirements (including date and time) _____

Supervisor of blasting _____ Address _____
 Penna. Blaster's License No.: _____

For Items No. 1, No. 2, No. 3 and No. 4	Location of Work <u>57 S. Malin Rd.</u> Owner _____ Address _____
--	---

5. **Street Opening** Location _____
 Purpose _____ Dimensions _____
 Date of work _____ Length of time open _____

6. **Other** Location _____
 Subdivision Plan Filing Engineer and Date of Plan _____
 Board of Adjustment Hearing No. of Hours _____
 Engineering Inspection Building Plumbing Zoning Subdivision
 Code Book Change of Zoning Hearing

In consideration of the sum of 15.00 Dollars, permission is hereby granted to the above applicant to proceed with the work as described in the application for this permit, which by reference is made a part hereof. The applicant agrees to assume all liability for, and save harmless the Township of Marple from any and all damages which may result from this purpose. This permit is subject to immediate revocation by the Township for any violation of the applicable Township Ordinances and the permittee is subject to the penalties provided by law. This permit expires 6 mos.

Received payment, [Signature]
 TOWNSHIP MANAGER

Copy to: Police Chief Tax Assessor Building Inspector Roadmaster
 Plumbing Inspector Refuse Site Custodian Board of Adjustment Manager

APPROVED BY DIRECTOR OF CODE ENFORCEMENT
OF MARPLE TOWNSHIP

Class R-4-Res

Present Bldg. S/F

New Bldg. or Add. Re Roof

Dist. R3 Permit Fee 15.00

Blaise W Jones Validated DATE 5/11/83

Permit No. 83-1580 Time 9:30 AM

THIS PORTION OF THE APPLICATION TO BE COMPLETED BY TOWNSHIP

APPLICATION FOR PERMIT FOR ADDITIONS, ALTERATIONS,
REPAIRS, TOOL SHEDS, GARAGES, DEMOLITIONS, ETC.

TO THE BOARD OF COMMISSIONERS OF MARPLE TOWNSHIP:

I (We) hereby apply for a permit to construct the following work (Give exact location):

Street and number 57 South Malin Rd.

Dimensions of Lot 50x135 Number of streets on which bldg. will front ONE

Distance of bldg. from Property Line _____ Side _____ Side _____

Front Line _____ Rear Line _____

Give definite particulars as to work proposed and materials used:

Remove two roofs and replace with new roof with shingles

Estimated Cost (All Trades) \$6000.00 Time of Commencing 5/20/83

Notwithstanding the issuance of this permit, all provisions of the Building and Zoning Codes will be complied with, whether specified herein or not.

Owner Sal Helmus Address 57 S. MALIN RD.

Architect _____ Address _____

Contractor _____ Address _____

Applicant _____ Address _____

Date 5/11/83

Sal Helmus
Owner or Builder

Applicant must draw sketch of house and any outbuildings on the lot, existing or to be erected, and indicated dimensions from each building to each property line and between buildings.

REAR PROPERTY LINE

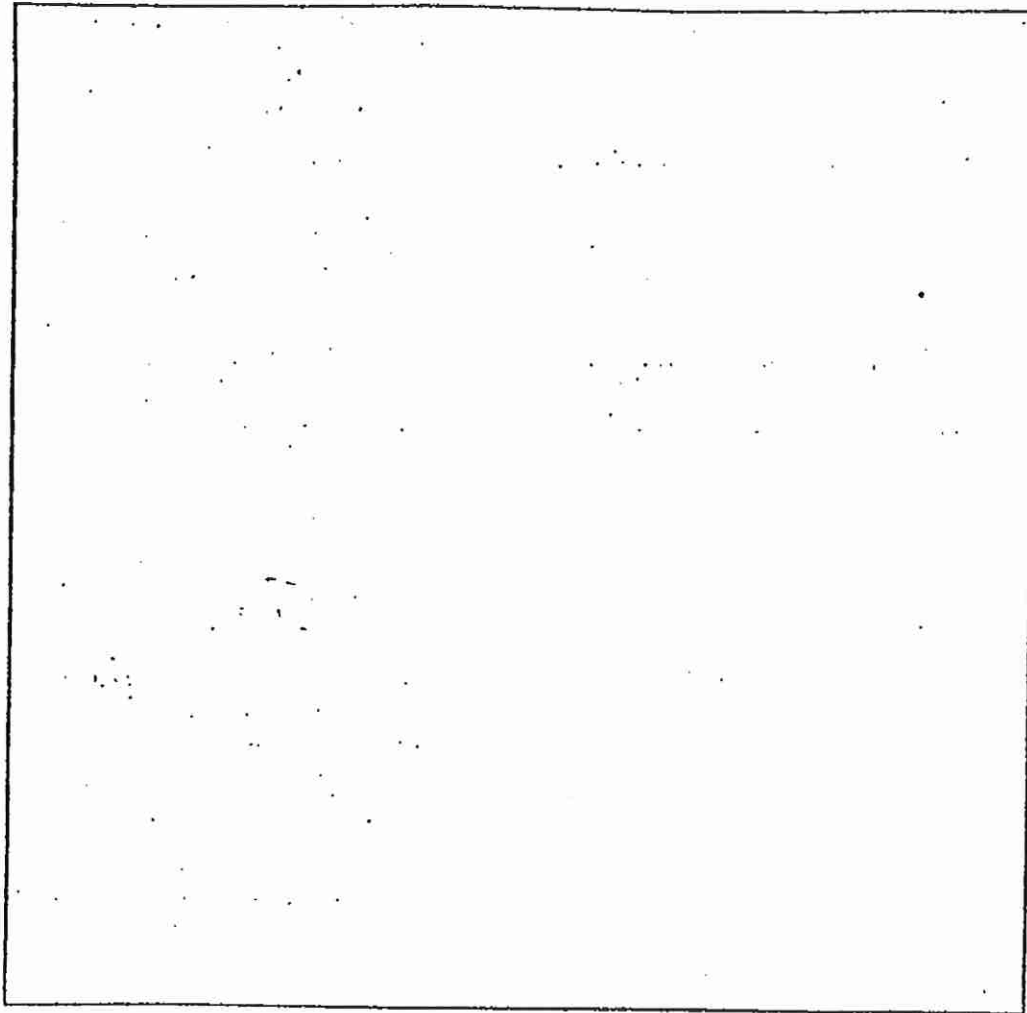

FRONT PROPERTY LINE

FOR NOTARY PUBLIC

Sworn and subscribed before me this 11th day of May, 1983

Hope S. Smith
Notary Public, Marple Township, Delaware Co.
My Commission Expires June 10, 1984
HOPE S. SMITH

Applicant's Signature Sol Helmus

APPLICATION

<p style="text-align: center;">ELECTRICAL PERMIT</p> <p>NOTE: Plans are required for all electrical work exceeding \$2500.</p>	<p style="text-align: center;">TOWNSHIP OF MARPLE SPRINGFIELD & SPROUL ROADS BROOMALL, PENNSYLVANIA 19008</p> <p style="text-align: center;">CODE ENFORCEMENT DEPARTMENT</p>	<p>PERMIT NO. 87-1418</p> <p>ESTIMATED COST \$75.00</p> <p>FEE 15.00</p> <p>PLAN NO.</p> <p>ZONING DISTRICT</p> <p>DISTRICT NO.</p> <p>CERT. OF OCCUP. NO.</p>
<p>LOCATION 57 S MA L W Rd</p>	<p>USE OF PREMISES Residence</p>	<p>DATE ISSUED 4/22/87</p>
<p>NAME OF INSTALLER JAMES A-M EARLEAN</p>	<p>ADDRESS OF INSTALLER 4109 SPENCER ST PHILA PA 19126</p>	<p>REPAIR <input type="checkbox"/></p> <p>ALTERNATION <input type="checkbox"/></p> <p>BUS. BLDG. <input type="checkbox"/></p> <p>ELECTRIC HEAT <input type="checkbox"/></p> <p>OTHER (SPECIFY)</p>
<p>NAME OF OWNER ARMON D</p>	<p>ADDRESS OF OWNER 57 S. MALIN</p>	<p>REPLACEMENT <input checked="" type="checkbox"/></p>
<p>INSPECTING AGENCY FOR INSPECTION William S. ... (Gen. ...)</p>	<p>LICENSE NO.</p>	<p>APR. BLDG. <input type="checkbox"/></p> <p>GAS BURNING EQUIPMENT <input type="checkbox"/></p> <p>OIL BURNING EQUIPMENT <input type="checkbox"/></p> <p>AIR CONDITIONING <input type="checkbox"/></p> <p>NEW CONSTRUCTION <input type="checkbox"/></p>
<p>TYPE OF ELECTRICAL WORK</p> <p>Service Grounded Red. & Wiring</p>		
<p>NOTE: ALL ELECTRICAL WORK SHALL CONFORM WITH ORDINANCE NO. 80.6</p>		
<p>I HEREBY CERTIFY THAT THE STATEMENTS CONTAINED HEREIN ARE TRUE TO THE BEST OF MY KNOWLEDGE AND BELIEF.</p> <p><i>James A. M. Earlean</i> (Applicant's Signature)</p>	<p>DATE COMPLETED</p>	<p>APPROVED BY</p> <p><i>Armond Baroni</i> Approved By</p>

CODE	REV			
	DISB			

**MARPLE TOWNSHIP
DELAWARE COUNTY, PENNSYLVANIA
PERMITS AND FEES**

87 1418

04/22/87 8:34AM GEN'L \$15.00

.....4-22..... 19.87
 Name: James McErlan Street: 410 W Spencer St City: St Phila
 Fee, \$.....15.00.....

has made application for permits or fees indicated below, in accordance with the terms and conditions set forth in the applicable Township Ordinances.

1. **Building**
 - () New Dwelling () Garage () Addition () Alteration-Repair
 - () Other
2. **Plumbing**
 - () New Work () Alterations () Sewer () Cesspool & Septic Tank
 - () Oil Burner () Gas Appliance () Plumber's Registration
 - () Other
3. **Storage of Explosives**
 - Purpose
 - No. of pounds Type
4. **Blasting**
 - Purpose Bond () Insurance ()
 - Type of explosive Maximum charge
 - Special Requirements (includes date and time)
 -
 - Supervisor of blasting Address
 - Penna. Blaster's License No.:

For Items	Location of Work
No. 1, No. 2, No. 3 and No. 4	Owner
	Address

5. **Street Opening**
 - Purpose
 - Date of work
 - Location
 - Dimensions
 - Length of time open
6. **Other**
 - () Subdivision Plan Filing
 - () Board of Adjustment Hearing
 - () Engineering Inspection
 - () Code Book Building Plumbing Zoning Subdivision
 - () Change of Zoning Hearing

In consideration of the sum of Dollars, permission is hereby granted to the above applicant to proceed with the work as described in the application for this permit, which by reference is made a part hereof. The applicant agrees to assume all liability for, and save harmless the Township of Marple from, any and all damages which may result from this purpose. This permit is subject to immediate revocation by the Township for any violation of the applicable Township Ordinances and the permittee is subject to the penalties provided by law. This permit expires

Received payment,
Joseph W. Flecker
 TOWNSHIP MANAGER

Copy to: () Police Chief () Tax Assessor () Building Inspector () Roadmaster
 () Plumbing Inspector () Refuse Site Custodian () Board of Adjustment () Manager